

Open a tea-bag envelope from the bottom with a toothpick.

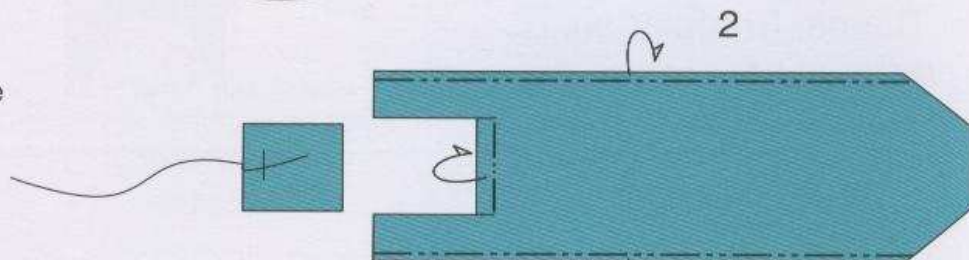

Fold behind (or cut if you don't have a neat edge).

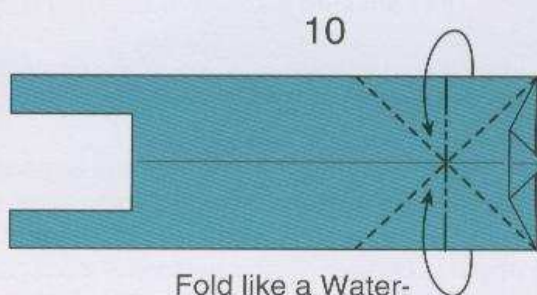
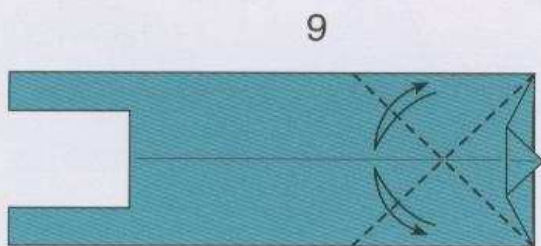
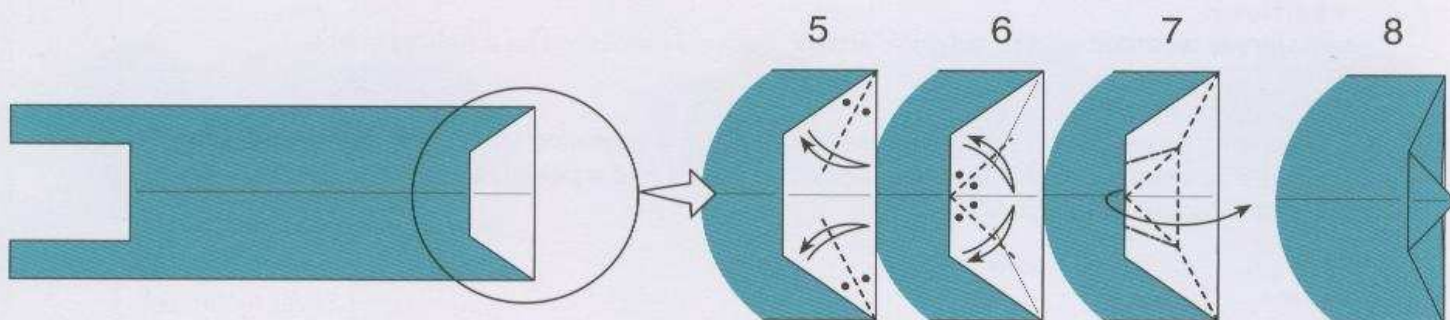
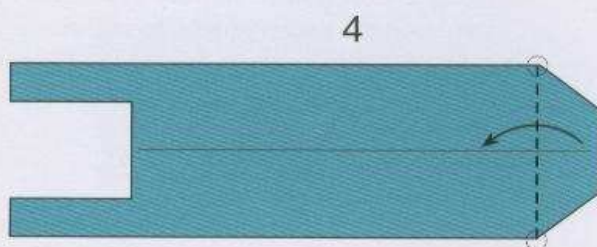
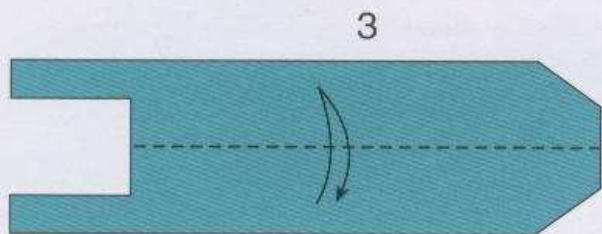

Fold like a Water-bomb base.

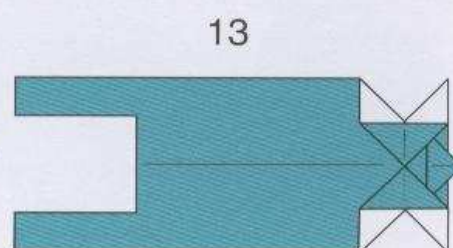
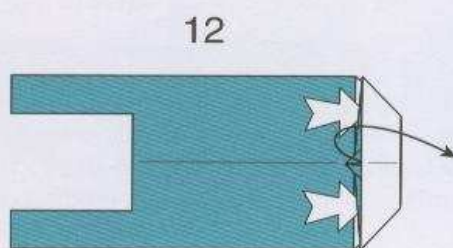
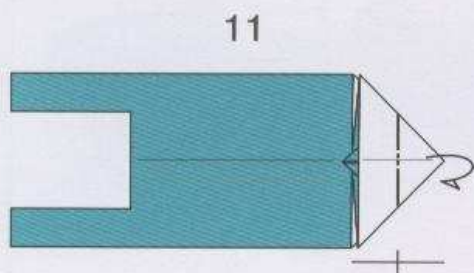



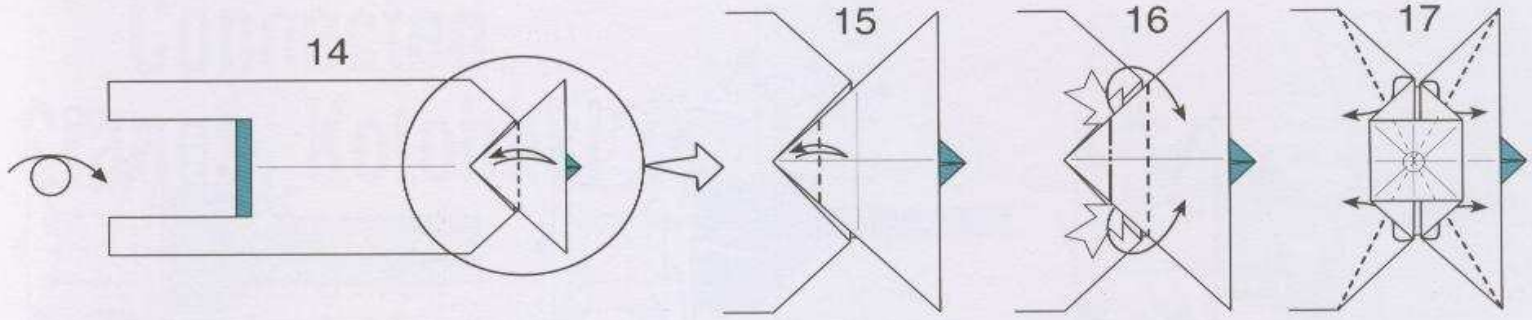

Spread and squash at the middle.

Inside reverse-fold (the angles will not be bisected).

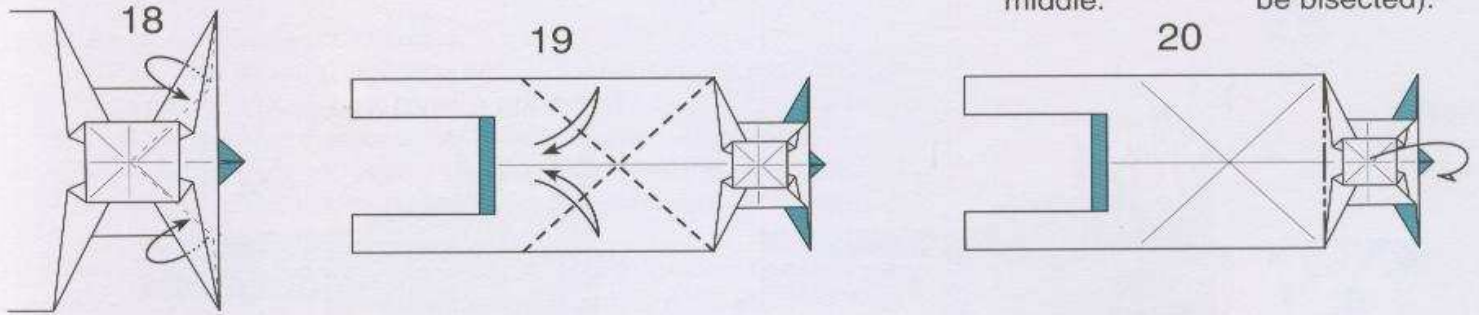

Wrap to hide the white part.

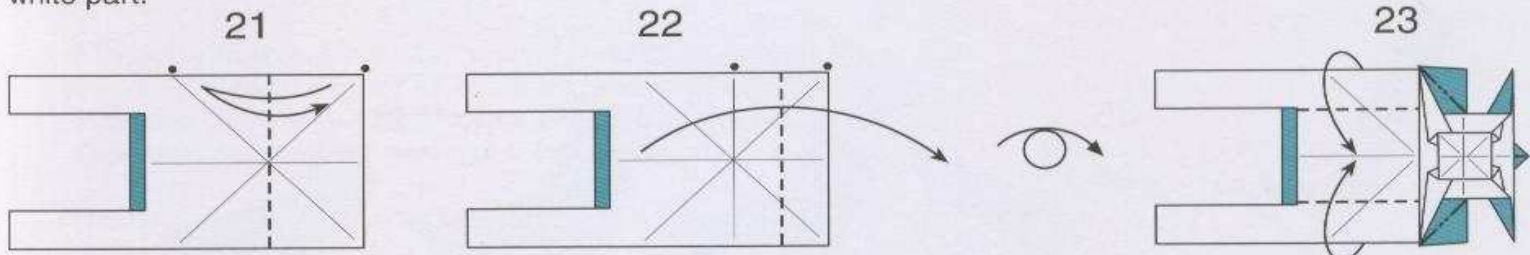

Swivel-fold

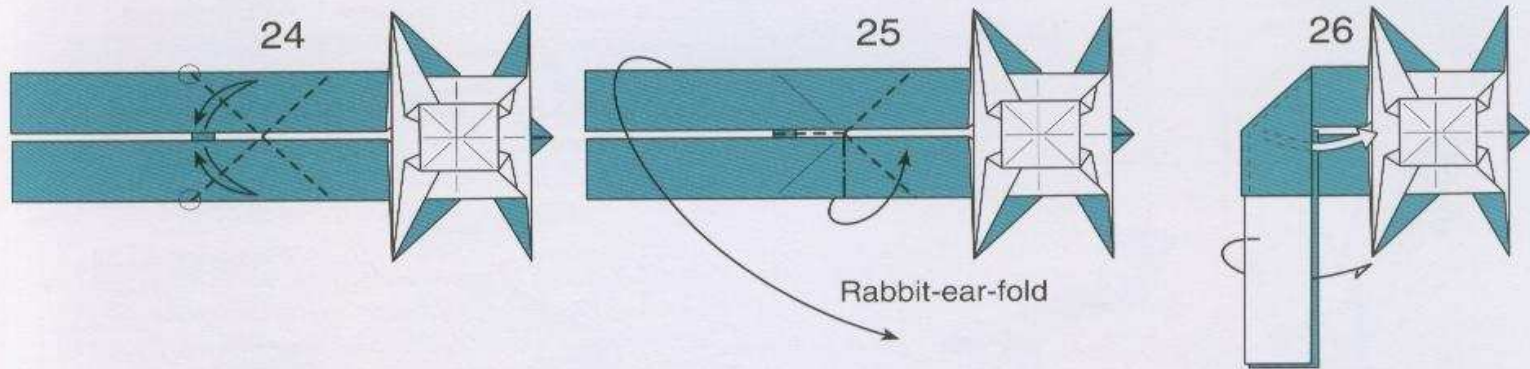

Rabbit-ear-fold

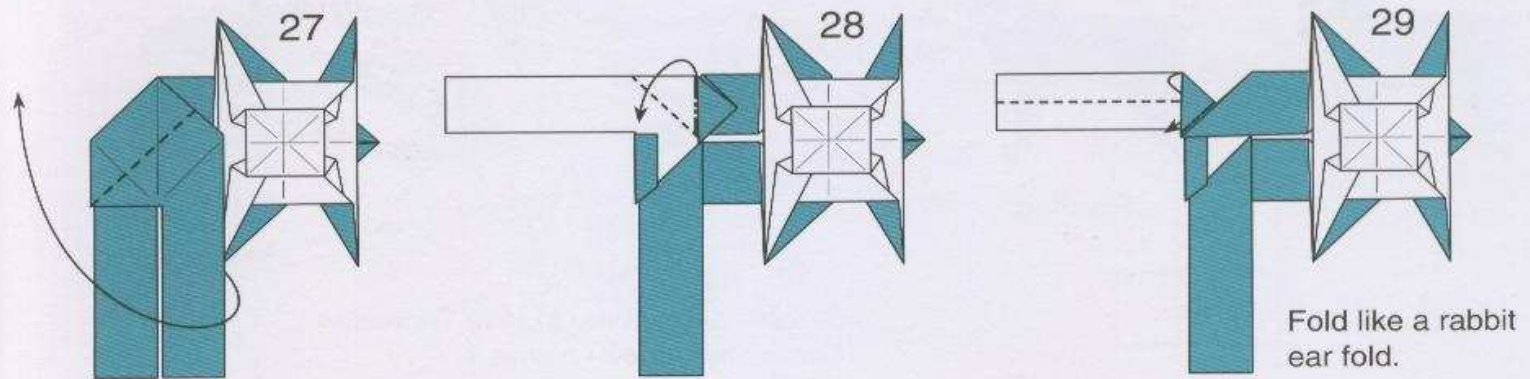

Fold like a rabbit ear fold.



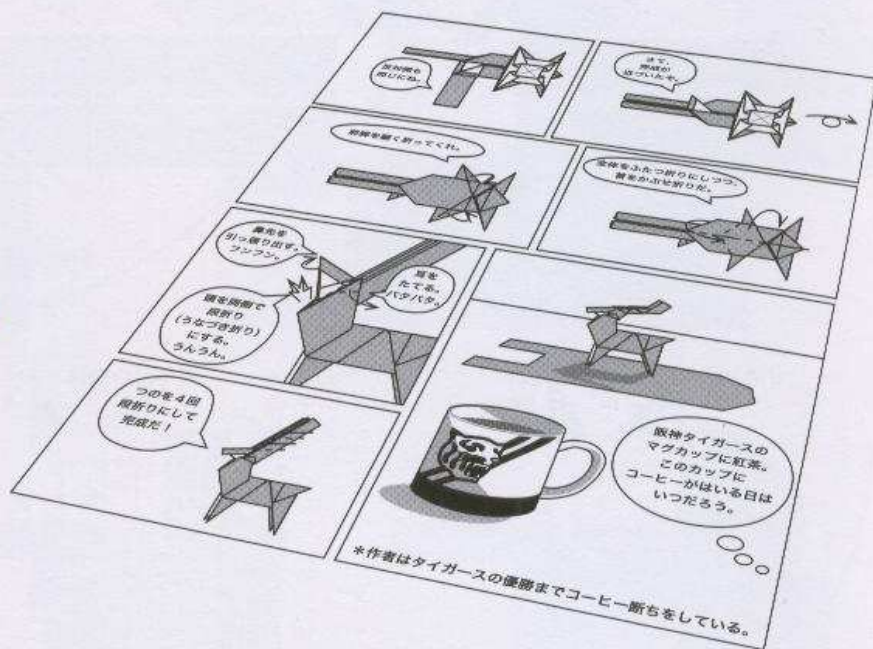
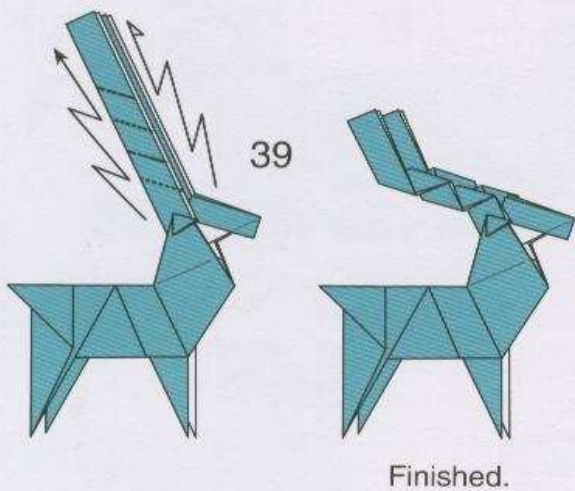
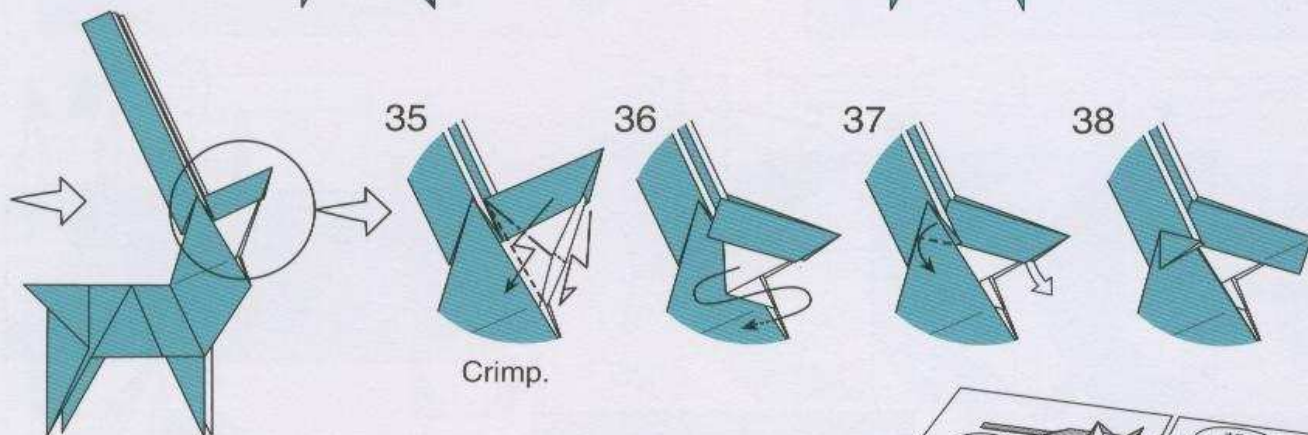
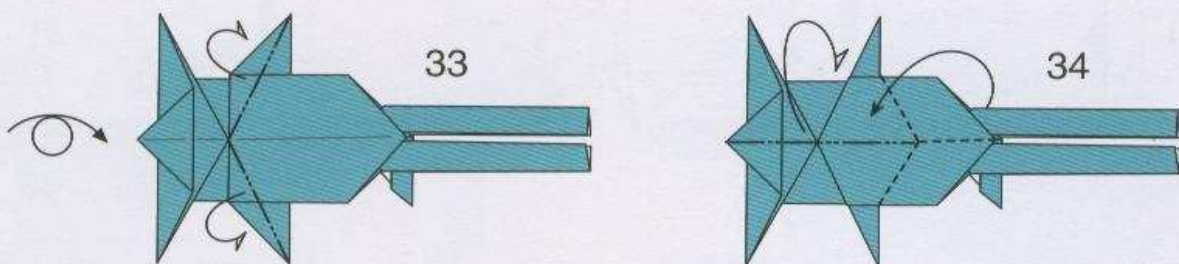
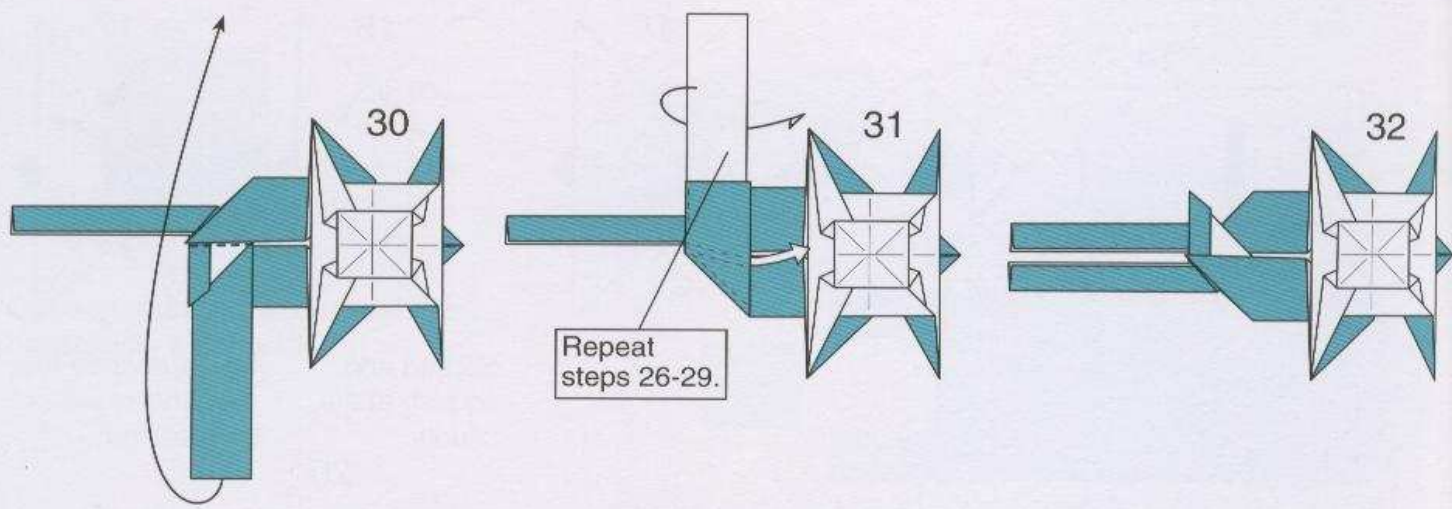

Sample page from *Origami Tanteidan Convention Book volume 3*  
(1997, self-publication, out-of-print)